

# FIND HELP

## SAFETY

## PREPARATION

## WHAT'S IN THE BOX

## INSTALL DOCK

Tools Needed

## ADD A SPA

## SET UP PUREZONE WITH DOCK

## SET UP PUREZONE WITH HOVER

## REPLACE THE CASSETTE

## RECHARGE THE BATTERY

## YOUR PUREZONE SYSTEM

LED Status

FCC Information

Specifications

Troubleshooting

Ordering

Warranty

Software Agreement

# purezone™

## USER GUIDE

Purezone  
with a Dock



Purezone  
with a Hover



Purezone  
app

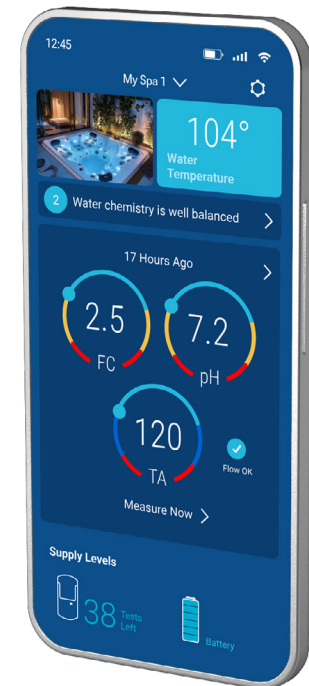

# FIND HELP

## SAFETY

## PREPARATION

## WHAT'S IN THE BOX

## INSTALL DOCK

[Tools Needed](#)

## ADD A SPA

## SET UP PUREZONE WITH DOCK

## SET UP PUREZONE WITH HOVER

## REPLACE THE CASSETTE

## RECHARGE THE BATTERY

## YOUR PUREZONE SYSTEM

[LED Status](#)

[FCC Information](#)

[Specifications](#)

[Troubleshooting](#)

[Ordering](#)

[Warranty](#)

[Software Agreement](#)

# SAFETY

The Purezone System has been designed and tested to offer safe service provided it is installed, operated, maintained and tested in strict accordance with the instructions and warnings contained in this guide.

## SAFETY SYMBOL AND SIGNAL WORDS

### WARNING

When you see these Safety Symbols and Signal Words on the following pages, they will alert you to the possibility of serious injury or death if you do not comply with the warnings that accompany them. The hazard may come from something mechanical or from electric shock. Read all instructions warnings materials carefully.

### CAUTION

When you see this Signal Word on the following pages, it will alert you to the possibility of damage to your property or product if you do not comply with the cautionary statements that accompany it. Read the cautionary statements carefully.

## IMPORTANT SAFETY INSTRUCTIONS

- For Residential or Commercial Use.
- READ AND FOLLOW ALL WARNINGS, SAFETY MATERIALS AND INSTRUCTIONS CAREFULLY!
- The Purezone System WILL NOT WORK if the battery pack is not first adequately charged on the included charger, and then the Purezone System is not submerged in the spa water.
- The Purezone System ONLY works with Purezone products, parts and accessories by Balboa.

## WARNING

- Make sure the power supply is unplugged from the wall outlet when not in use.
- To reduce the risk of injury, do not permit children to use this product unless they are closely supervised at all times.
- Do not operate with a damaged cord or power supply. Contact the manufacturer for replacement parts.
- DANGER – Risk of Electric Shock. Do not permit the wireless charger, any electric appliance, such as a light, telephone, radio, or television, within 5 feet (1.5 m) of a spa or hot tub.
- Always be present when charging Li-ion battery products, charge in a cool, dry space, and only use the supplied charger.
- Only use an approved replacement battery pack.
- Follow the manufacturer's instructions for proper charging and unplug the device when done.
- Use ONLY manufacturer supplied parts.
- NEVER throw lithium batteries into the trash or general recycling. Instead, take them to your local battery recycler or hazardous waste collection center in accordance with local disposal laws.
- Heavy spa usage, and higher temperatures may require higher chlorine output to maintain proper free available chlorine residuals.
- If additional chlorine is required due to heavy bather loads, use liquid chlorine to maintain an appropriate chlorine residual in the water.
- Maintaining high salt and chlorine levels above recommended range can contribute to corrosion of spa equipment
- Check the expiry date of the Cassette as test results may be inaccurate if used after that date.
- No User Serviceable Parts.

# FIND HELP

## SAFETY

## PREPARATION

## WHAT'S IN THE BOX

## INSTALL DOCK

Tools Needed

## ADD A SPA

## SET UP PUREZONE WITH DOCK

## SET UP PUREZONE WITH HOVER

## REPLACE THE CASSETTE

## RECHARGE THE BATTERY

## YOUR PUREZONE SYSTEM

LED Status

FCC Information

Specifications

Troubleshooting

Ordering

Warranty

Software Agreement

# PUREZONE™

Purezone is an automated water monitoring system that tests, reports and tracks spa water chemical levels, including potential of hydrogen (pH), free chlorine (FC) or Total Bromine (TB), and Total Alkalinity (TA) using a replaceable cassette designed for chemical reagent testing. The Purezone App tells you the recommended chemical treatment from the test to help maintain clean, safe water standards for spa use.

## PREPARATION

### BEFORE YOU START:

- 1 Get the App, "Purezone by Balboa" and create an account.
- 2 Check that Bluetooth is on and Wi-Fi is available.

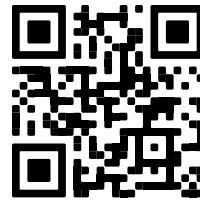

- 3 For best results, charge the battery pack over night prior to device set up.

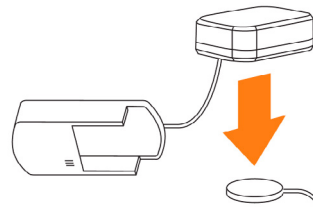

- 4 Gather the following information, or ask your spa service professional for:
  - Your sanitizer type (Example: Chlorinating Granules (Sodium Dichlor))
  - Your balancer and its concentration (Example: Sodium Bisulfate (Dry Acid), 93.2%)
  - Estimate how much water your spa holds (in gallons or liters)
  - You will need this information to customize your water care advice when you add your spa to be tested by Purezone in the App.

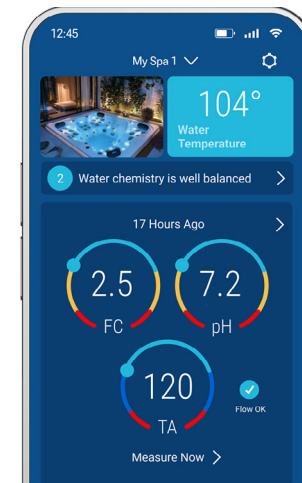

# FIND HELP

## SAFETY

## PREPARATION

## WHAT'S IN THE BOX

## INSTALL DOCK

Tools Needed

## ADD A SPA

## SET UP PUREZONE WITH DOCK

## SET UP PUREZONE WITH HOVER

## UDSKIFTNING AF KASSETTE

## RECHARGE THE BATTERY YOUR

## PUREZONE SYSTEM

LED Status

FCC Information

Specifications

Troubleshooting

Ordering

Warranty

Software Agreement

# WHAT'S IN THE BOX

**(NOTE: Items vary per customer order)**

1 Purezone (Battery Pack and Cassette Housing)

1 P3 Cassette (FC, pH, and TA) inside foil storage bag. Total bromine measurements are coming soon.

1 Battery Charger

1 Hover OR 1 Dock (per customer order)

1 Tie (not shown)

1 Hardware Kit (not shown)

Cassette

\*Keep the cassette dry in the foil bag until you use it.

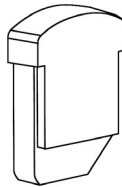

Dock

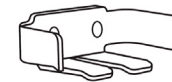

Cassette Foil Bag



Purezone Unit



Battery Pack

Cassette Housing

Wireless Charger



Hover

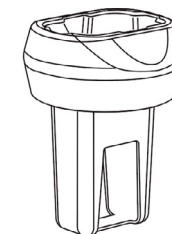

# FIND HELP

## SAFETY

## PREPARATION

## WHAT'S IN THE BOX

## INSTALL DOCK

Tools Needed

## ADD A SPA

## SET UP PUREZONE WITH DOCK

## SET UP PUREZONE WITH HOVER

## REPLACE THE CASSETTE

## RECHARGE THE BATTERY

## YOUR PUREZONE SYSTEM

LED Status

FCC Information

Specifications

Troubleshooting

Ordering

Warranty

Software Agreement

# INSTALL DOCK

(DOCK INSTALLATION ONLY)

## TOOLS NEEDED

If your spa does not already come with a Dock, you will need:

- Drill
- Stainless Steel 15/64" Bit
- Phillips Screw Driver
- Masking Tape
- Washable Marker
- Rubbing Alcohol

## TO INSTALL THE DOCK:

- 1 Determine an area on the spa where the Dock will be installed undisturbed, and place a 3" strip of masking tape on the area, approximately 2" parallel above the water line.  
This will create a nonslip surface as you drill.
- 2 Use the Dock to mark the tape where the drill holes should be.
- 3 Using a 15/64" stainless steel bit, slowly drill a hole through the tape marks.
- 4 Remove the tape and clean the mounting surface with rubbing alcohol.
- 5 Peel off the Dock sticker protection, align the holes and press onto the spa wall.
- 6 Insert the provided screws.  
**IMPORTANT: Do not over tighten.**
- 7 Proceed to "Add a Spa" on page 6.

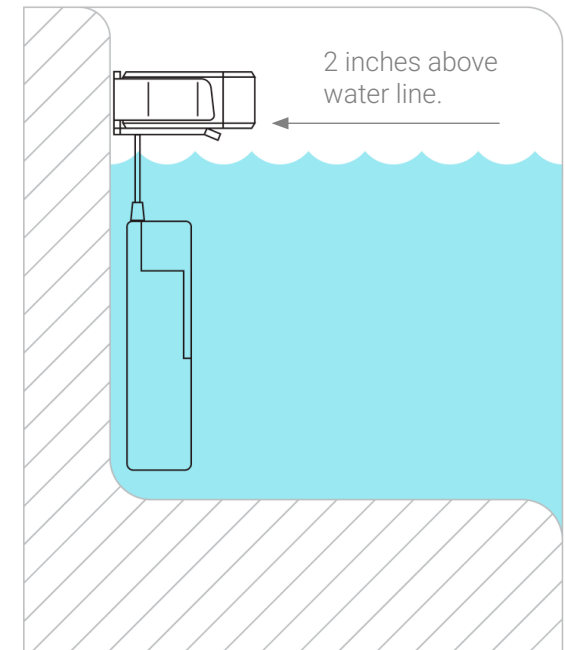
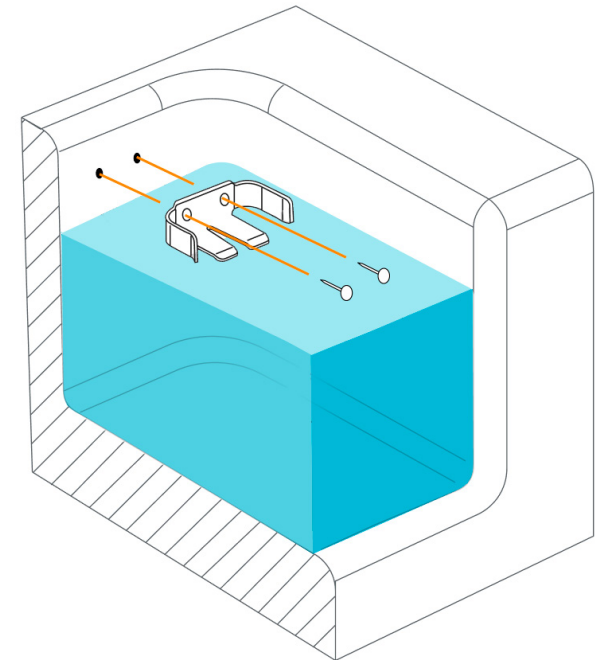

# FIND HELP

## SAFETY

## PREPARATION

## WHAT'S IN THE BOX

## INSTALL DOCK

Tools Needed

## ADD A SPA

## SET UP PUREZONE WITH DOCK

## SET UP PUREZONE WITH HOVER

## REPLACE THE CASSETTE

## RECHARGE THE BATTERY

## YOUR PUREZONE SYSTEM

LED Status

FCC Information

Specifications

Troubleshooting

Ordering

Warranty

Software Agreement

# ADD A SPA

With your Purezone account and Preparation complete, you're ready to add your spa to Purezone. In the App, tap **Add Spa**, and follow instructions.

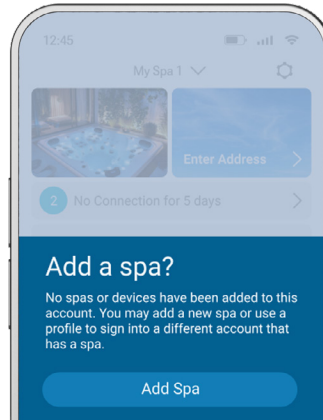

### To add a spa:

- 1 Assure Purezone unit is out of sleep mode by placing it on the wireless charger.

Ideally, the unit has been charged overnight before setup is initiated.

The battery pack is charging when the indicator light turns On.

The battery pack is charged when the indicator light turns Off.

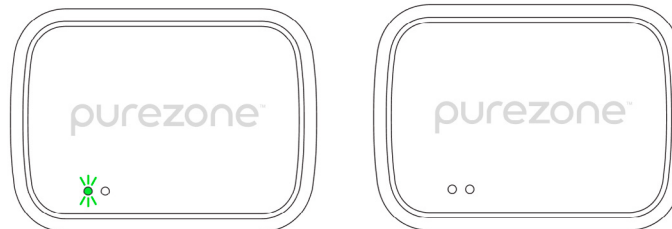

- 2 Remove the cassette from the foil storage bag when you are ready to use it.



Scan the QR code on the cassette.

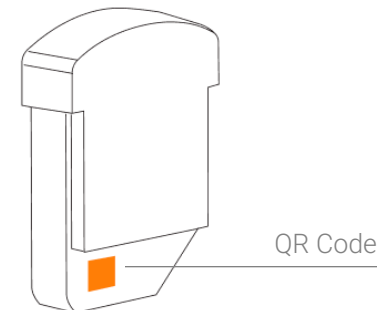

# FIND HELP

## SAFETY

## PREPARATION

## WHAT'S IN THE BOX

## INSTALL DOCK

Tools Needed

## ADD A SPA

## SET UP PUREZONE WITH DOCK

## SET UP PUREZONE WITH HOVER

## REPLACE THE CASSETTE

## RECHARGE THE BATTERY

## YOUR PUREZONE SYSTEM

LED Status

FCC Information

Specifications

Troubleshooting

Ordering

Warranty

Software Agreement

- 3 Install the cassette in the cassette housing.  
The cassette is installed when you hear a click.

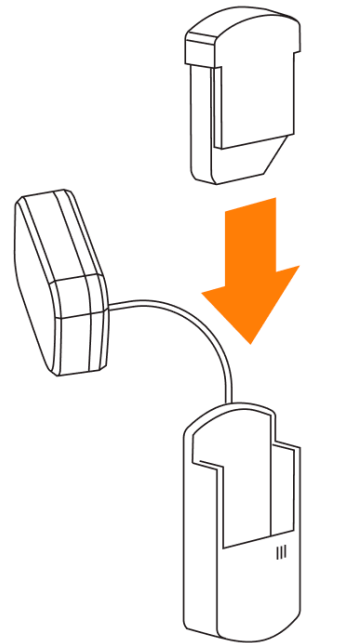

- 4 Select your Purezone system.

*"Set Up Purezone with Dock" on page 8.*

*"Set Up Purezone with Hover" on page 10.*

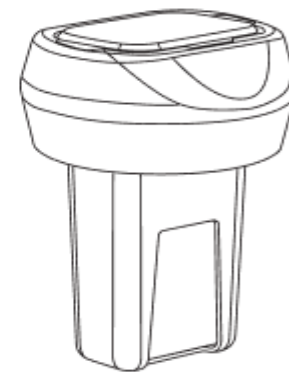

# FIND HELP

## SAFETY

## PREPARATION

## WHAT'S IN THE BOX

## INSTALL DOCK

Tools Needed

## ADD A SPA

## SET UP PUREZONE WITH DOCK

## SET UP PUREZONE WITH HOVER

## REPLACE THE CASSETTE

## RECHARGE THE BATTERY

## YOUR PUREZONE SYSTEM

LED Status

FCC Information

Specifications

Troubleshooting

Ordering

Warranty

Software Agreement

# SET UP PUREZONE WITH DOCK

**NOTE:** If your spa does not have a Dock, see "Install Dock" on page 5.

To set up the pre-installed Dock on your spa:

- 5 Insert the battery pack in the Dock.

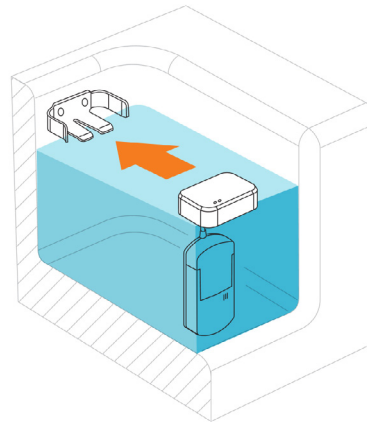

The cassette should be vertical and fully submerged, as shown here.

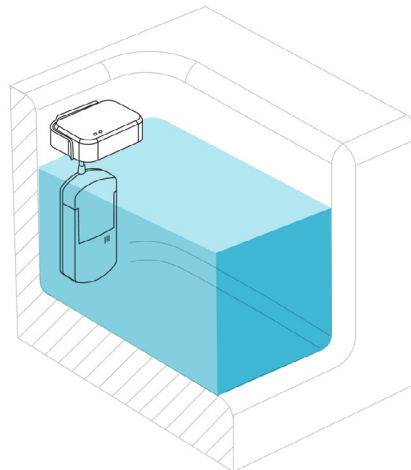

If extra cord prevents the cassette from hanging vertically, loop the extra cord with the tie.

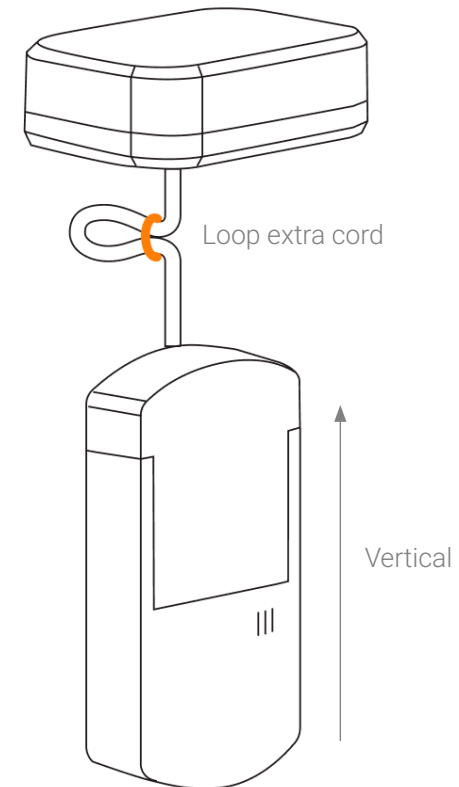

# FIND HELP

## SAFETY

## PREPARATION

## WHAT'S IN THE BOX

## INSTALL DOCK

Tools Needed

## ADD A SPA

## SET UP PUREZONE WITH DOCK

## SET UP PUREZONE WITH HOVER

## REPLACE THE CASSETTE

## RECHARGE THE BATTERY

## YOUR PUREZONE SYSTEM

LED Status

FCC Information

Specifications

Troubleshooting

Ordering

Warranty

Software Agreement

- 6 Assure that the cassette housing is fully submerged in water and the battery pack is above water.

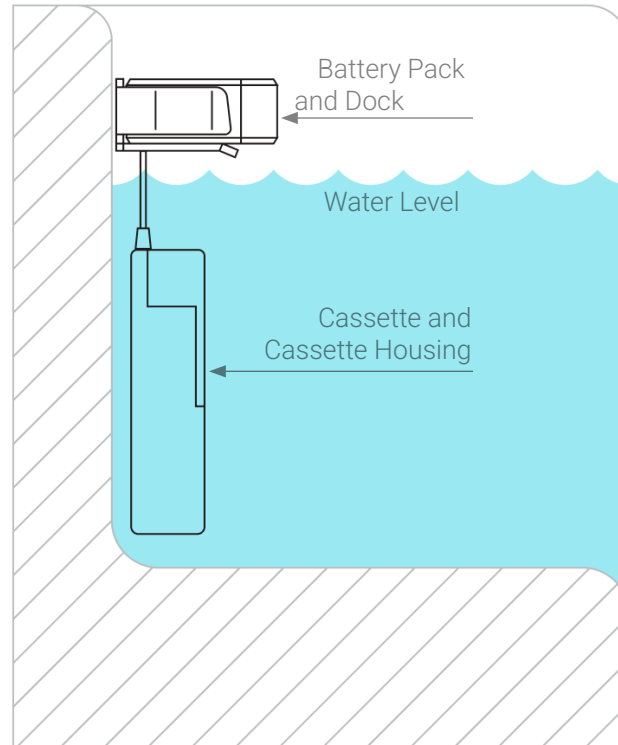

Now that Purezone is in the water, reinstall the water filter and the filter well cover, as needed.

- 7 Connect Purezone to the internet. Start by turning on Bluetooth.

The App displays your matching Purezone system for you to select.

- 8 Select your network.

Name your spa.

The App confirms you're connected.

You can now input your spa details to customize water care advice.

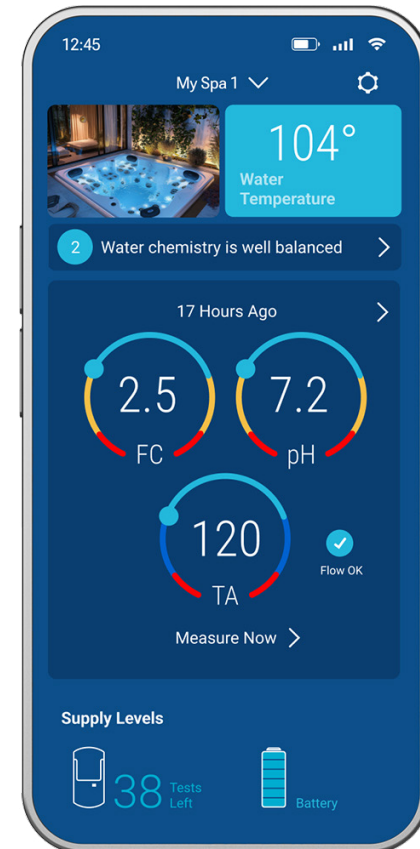

# FIND HELP

## SAFETY

## PREPARATION

## WHAT'S IN THE BOX

## INSTALL DOCK

Tools Needed

## ADD A SPA

## SET UP PUREZONE WITH DOCK

## SET UP PUREZONE WITH HOVER

## REPLACE THE CASSETTE

## RECHARGE THE BATTERY

## YOUR PUREZONE SYSTEM

LED Status

FCC Information

Specifications

Troubleshooting

Ordering

Warranty

Software Agreement

# SET UP PUREZONE WITH HOVER

To set up the Hover:

- 5 Insert the assembled Purezone unit into the Hover. The battery pack is inserted when you hear a click.

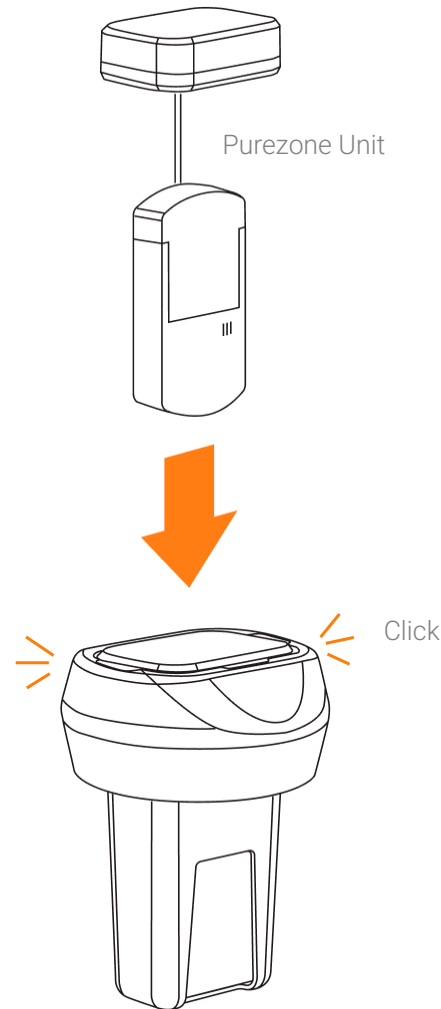

- 6 Place the assembled Purezone unit in your spa.

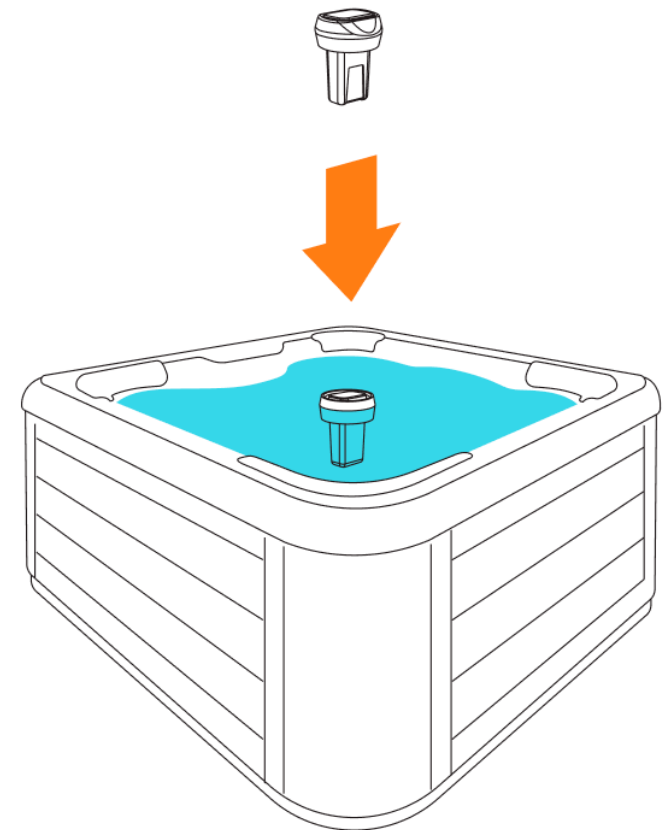

# FIND HELP

## SAFETY

## PREPARATION

## WHAT'S IN THE BOX

## INSTALL DOCK

Tools Needed

## ADD A SPA

## SET UP PUREZONE WITH DOCK

## SET UP PUREZONE WITH HOVER

## REPLACE THE CASSETTE

## RECHARGE THE BATTERY

## YOUR PUREZONE SYSTEM

LED Status

FCC Information

Specifications

Troubleshooting

Ordering

Warranty

Software Agreement

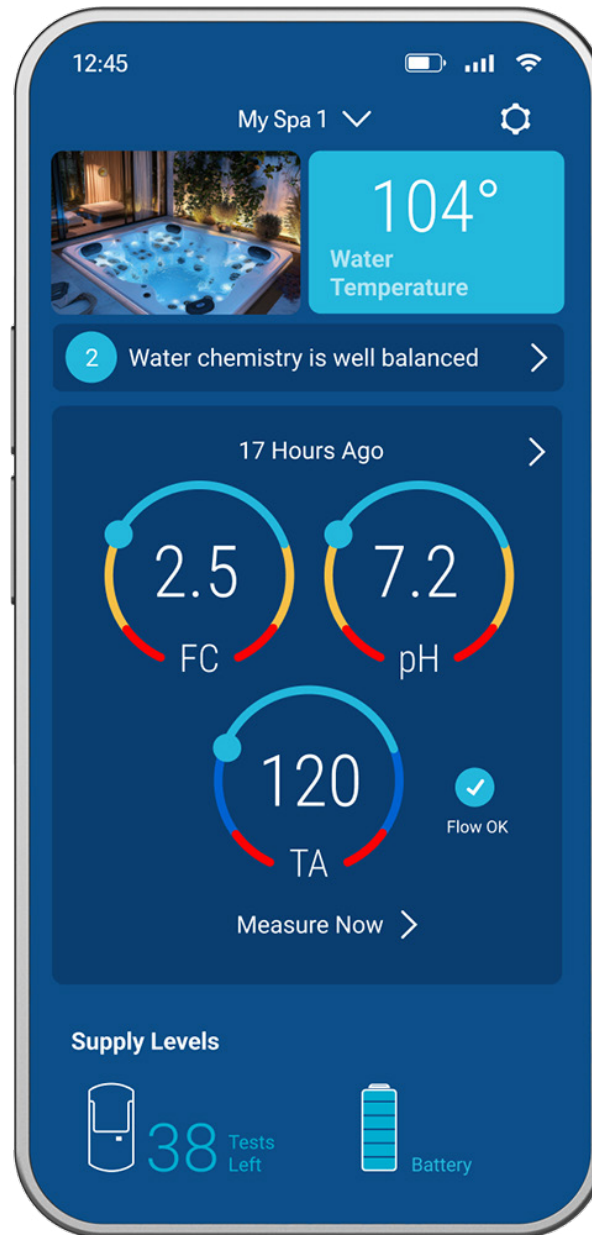

7 Connect Purezone to the internet. Start by turning on Bluetooth.

The App displays your matching Purezone system for you to select.

8 Select your Wi-Fi network.

9 Name your spa.

The App confirms you're connected.

You can now input your spa details to customize water care advice.

# FIND HELP

## SAFETY

## PREPARATION

## WHAT'S IN THE BOX

## INSTALL DOCK

Tools Needed

## ADD A SPA

## SET UP PUREZONE WITH DOCK

## SET UP PUREZONE WITH HOVER

## REPLACE THE CASSETTE

## RECHARGE THE BATTERY

## YOUR PUREZONE SYSTEM

LED Status

FCC Information

Specifications

Troubleshooting

Ordering

Warranty

Software Agreement

# REPLACE THE CASSETTE

The Purezone App displays the supply levels which indicate when the cassettes are depleted, lasting 48 tests up to 60 days in water.



## To replace the cassette:

- 1 Remove Purezone from the spa.
- 2 Use only your fingers to pull the battery pack from the Dock or Hover.

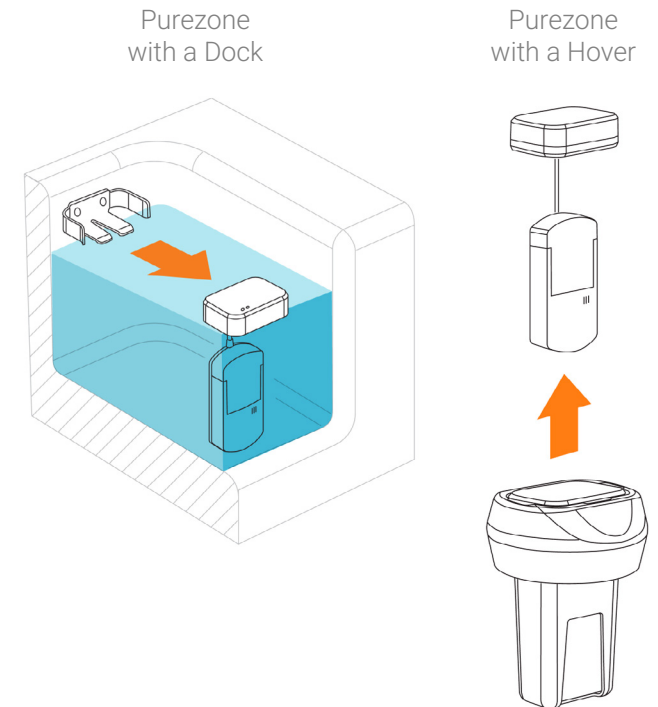

# FIND HELP

## SAFETY

## PREPARATION

## WHAT'S IN THE BOX

## INSTALL DOCK

Tools Needed

## ADD A SPA

## SET UP PUREZONE WITH DOCK

## SET UP PUREZONE WITH HOVER

## REPLACE THE CASSETTE

## RECHARGE THE BATTERY

## YOUR PUREZONE SYSTEM

LED Status

FCC Information

Specifications

Troubleshooting

Ordering

Warranty

Software Agreement

- 3 Press the ridged sides in and pull the cassette out of the housing.  
Pat dry the housing and battery pack.

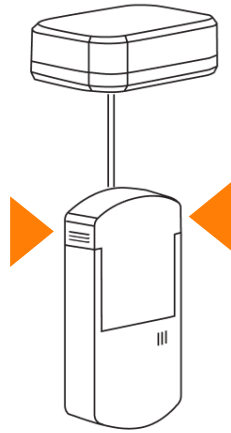

- 4 Remove the new cassette from its foil storage bag.

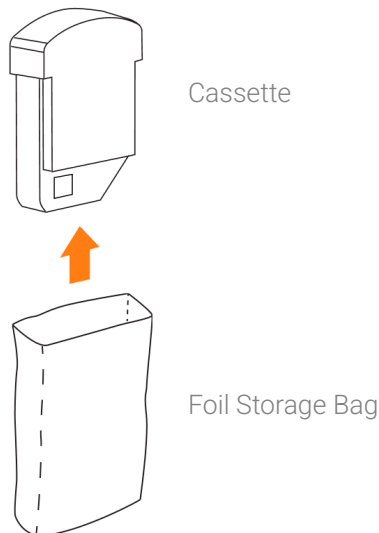

- 5 Tap "Replace Cassette" in-App to scan the QR code on the cassette.

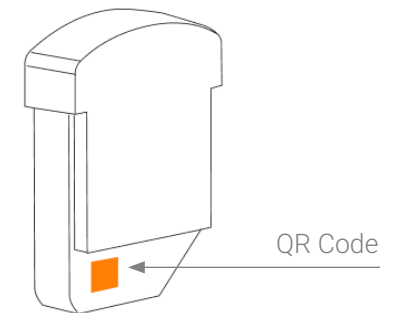
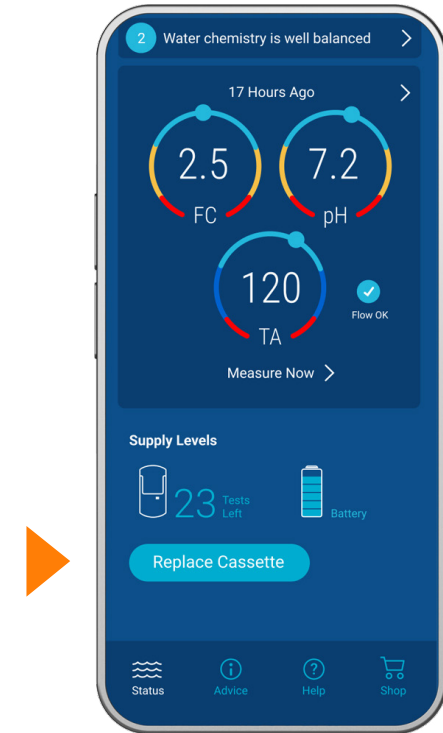

# FIND HELP

## SAFETY

## PREPARATION

## WHAT'S IN THE BOX

## INSTALL DOCK

Tools Needed

## ADD A SPA

## SET UP PUREZONE WITH DOCK

## SET UP PUREZONE WITH HOVER

## REPLACE THE CASSETTE

## RECHARGE THE BATTERY

## YOUR PUREZONE SYSTEM

LED Status

FCC Information

Specifications

Troubleshooting

Ordering

Warranty

Software Agreement

- 6 Install the cassette in the cassette housing. The cassette is installed when you hear a click.

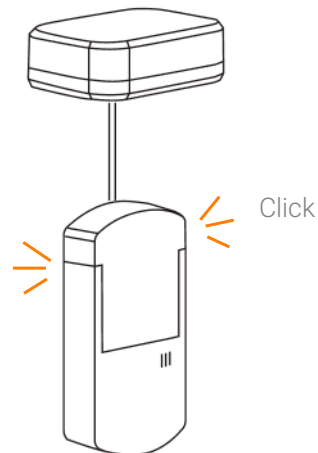
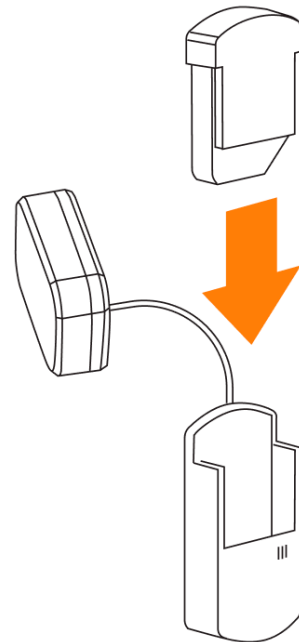

- 7 Insert the assembled Purezone unit into the Dock or Hover, depending on your model.

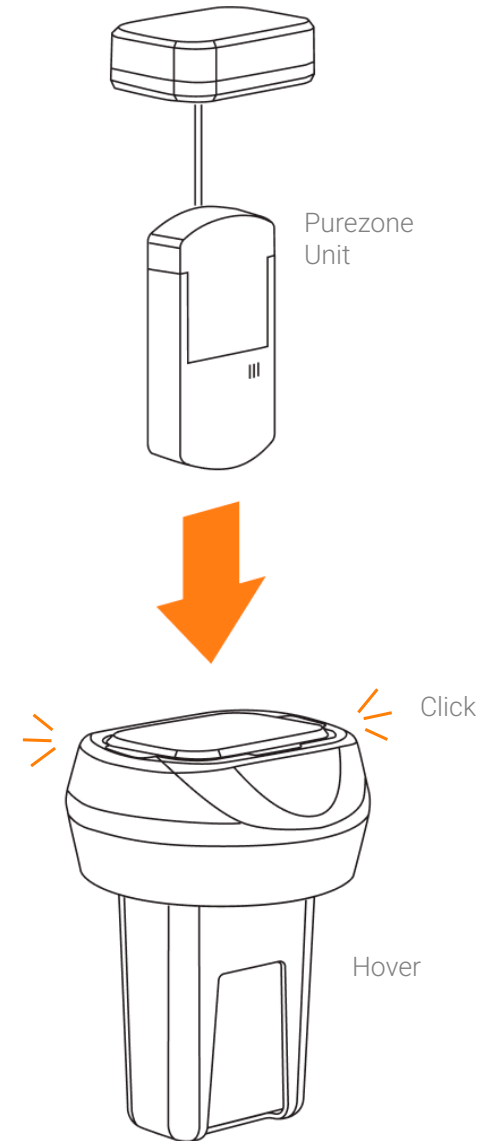

# FIND HELP

## SAFETY

## PREPARATION

## WHAT'S IN THE BOX

## INSTALL DOCK

Tools Needed

## ADD A SPA

## SET UP PUREZONE WITH DOCK

## SET UP PUREZONE WITH HOVER

## REPLACE THE CASSETTE

## RECHARGE THE BATTERY

## YOUR PUREZONE SYSTEM

LED Status

FCC Information

Specifications

Troubleshooting

Ordering

Warranty

Software Agreement

8 Place Purezone in the spa water.

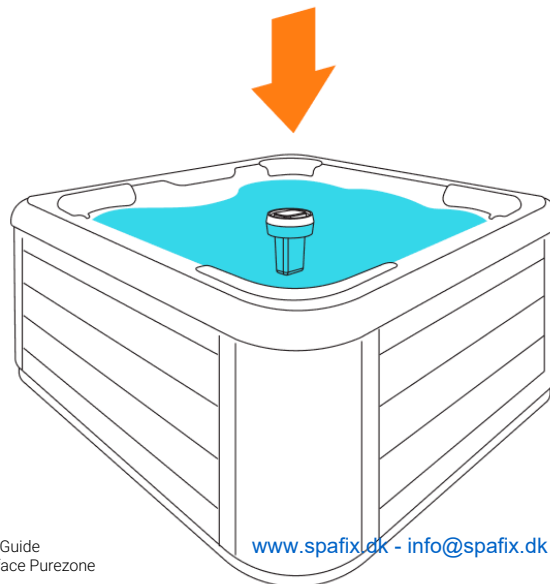
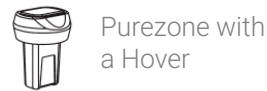
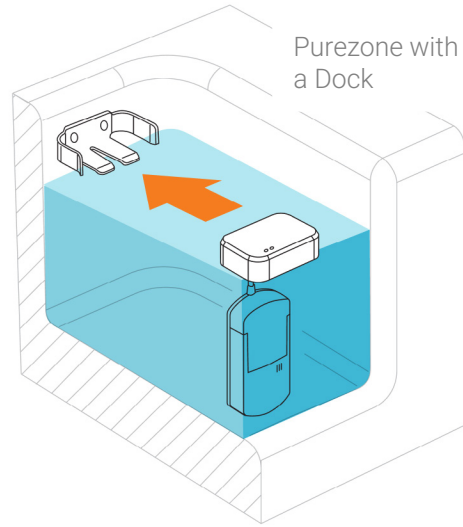

9 Check the Purezone App to see monitoring is active and cassette status is reset. Refresh your screen as needed.

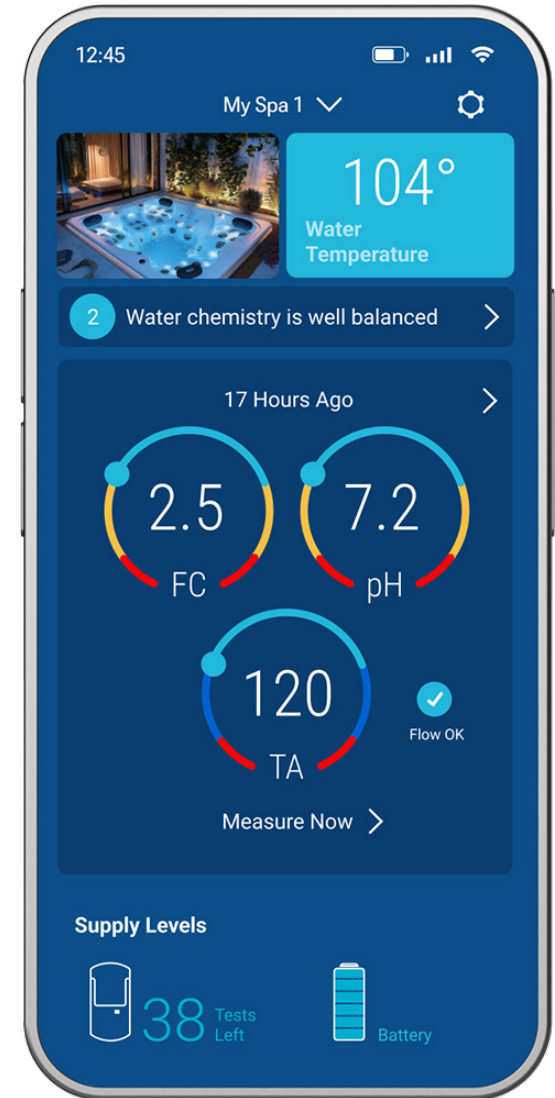

# FIND HELP

## SAFETY

## PREPARATION

## WHAT'S IN THE BOX

## INSTALL DOCK

Tools Needed

## ADD A SPA

## SET UP PUREZONE WITH DOCK

## SET UP PUREZONE WITH HOVER

## REPLACE THE CASSETTE

## RECHARGE THE BATTERY

## YOUR PUREZONE SYSTEM

LED Status

FCC Information

Specifications

Troubleshooting

Ordering

Warranty

Software Agreement

# RECHARGE THE BATTERY

The Purezone App displays the battery status to let you know charge life.

**IMPORTANT: Recommended charging overnight before use for best results.**

To charge the battery:

- 1 Remove Purezone from the spa. The battery pack flashes orange.



Battery Pack

- 2 Use only your fingers to pull the battery from the Hover or Dock.

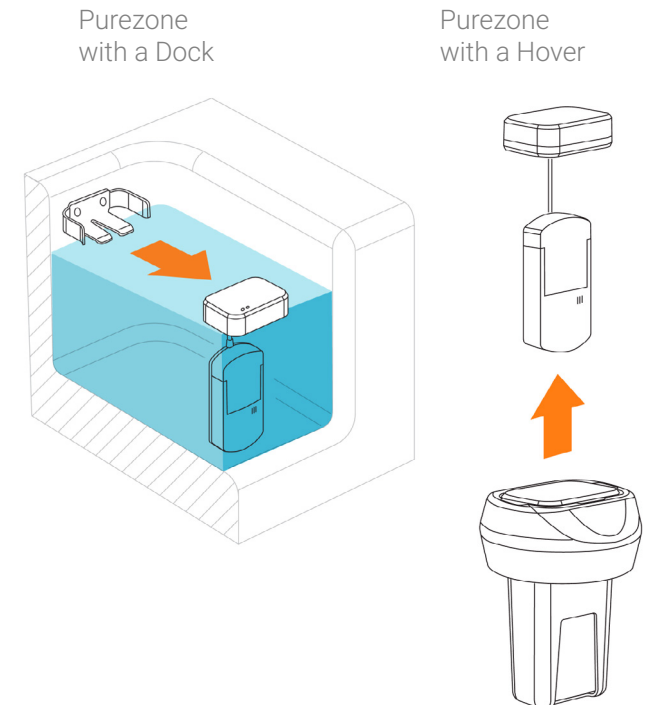

# FIND HELP

## SAFETY

## PREPARATION

## WHAT'S IN THE BOX

## INSTALL DOCK

Tools Needed

## ADD A SPA

## SET UP PUREZONE WITH DOCK

## SET UP PUREZONE WITH HOVER

## REPLACE THE CASSETTE

## RECHARGE THE BATTERY

## YOUR PUREZONE SYSTEM

LED Status

FCC Information

Specifications

Troubleshooting

Ordering

Warranty

Software Agreement

- Pat dry the battery and charge it overnight. View charging progress in the App.

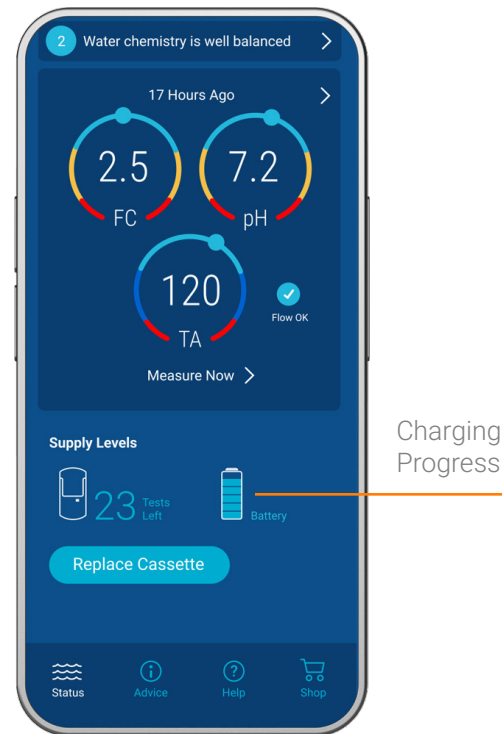
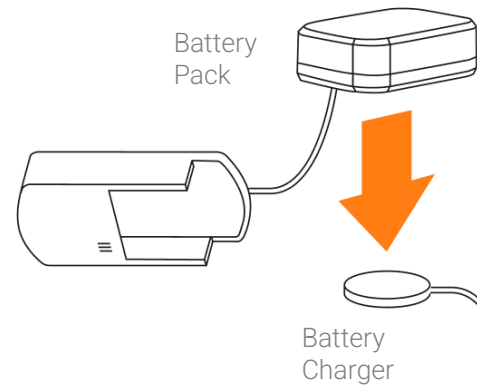

- Insert the assembled Purezone unit into the Dock or Hover until you hear a click/

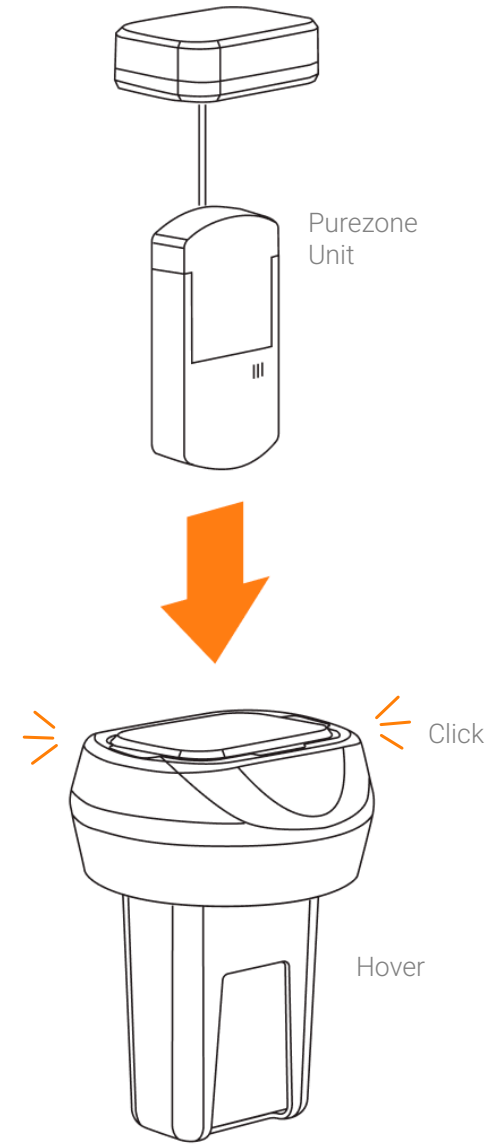

# FIND HELP

## SAFETY

## PREPARATION

## WHAT'S IN THE BOX

## INSTALL DOCK

Tools Needed

## ADD A SPA

## SET UP PUREZONE WITH DOCK

## SET UP PUREZONE WITH HOVER

## REPLACE THE CASSETTE

## RECHARGE THE BATTERY

## YOUR PUREZONE SYSTEM

LED Status

FCC Information

Specifications

Troubleshooting

Ordering

Warranty

Software Agreement

5 Place Purezone in the spa water.

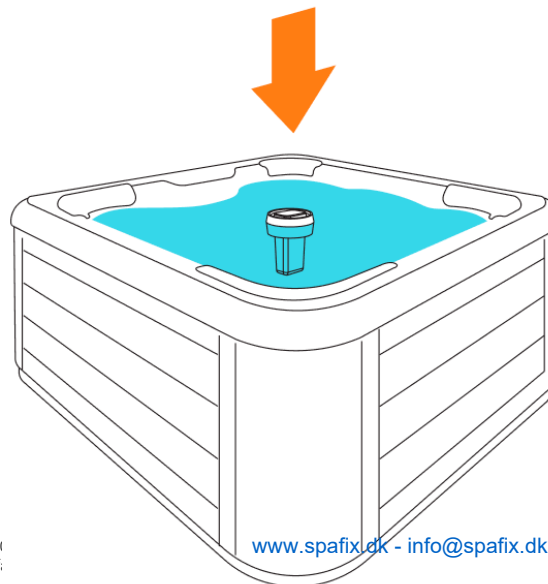
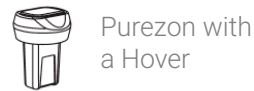
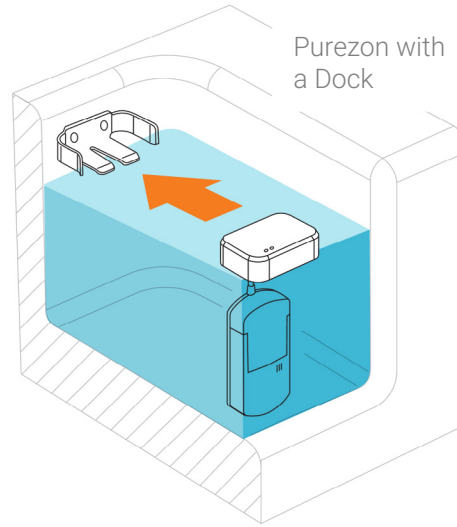

6 Check the Purezone App to see the new battery status.  
Your battery displays the new charge life.

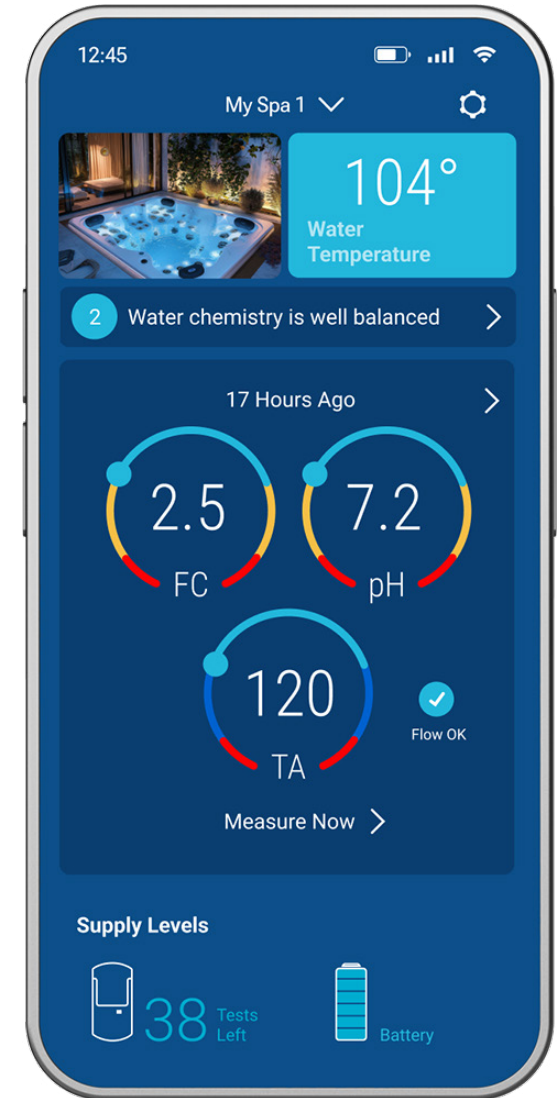

# FIND HELP

## SAFETY

## PREPARATION

## WHAT'S IN THE BOX

## INSTALL DOCK

[Tools Needed](#)

## ADD A SPA

## SET UP PUREZONE WITH DOCK

## SET UP PUREZONE WITH HOVER

## REPLACE THE CASSETTE

## RECHARGE THE BATTERY

## YOUR PUREZONE SYSTEM

[LED Status](#)

[FCC Information](#)

[Specifications](#)

[Troubleshooting](#)

[Ordering](#)

[Warranty](#)

[Software Agreement](#)

# YOUR PUREZONE SYSTEM

Test and monitor your spa water from anywhere, **without** testing kits, using your phone.

- Automates testing for every-other-day (default) or daily care, and also offers on-demand testing, whether you're home or away
- Monitors for potential of hydrogen (pH), free chlorine (FC) or Total Bromine (TB), and Total Alkalinity (TA)
- Testing is done using smart cassettes, each lasting 48 tests up to 60 days in water
- Runs on rechargeable Li-ion battery power
- Sends test results and advice to rebalance water quality
- Displays status on cassette and battery life in-App
- Available options include Purezone for Dock-ready spas and float-style Purezone with Hover, and come with the Purezone App, wireless charger and cassette

## LED STATUS

LED Colors	What You See	What It Means
None (out of the box)	Battery pack displays no light.	Purezone is in sleep mode. Place battery pack on the charger to wake up.
Orange and green flash briefly.	As you place the battery on the charger for the first time, you may see orange and green flash.	The new battery pack has just started to charge. Recommended: Charge over night for best results.
Solid green.	While charging, you will see solid green on the battery.	Charging is in progress. Wait for battery pack to complete charging and LED to turn off.
LED is solid green and then turned off while charging.	The battery pack is charged. Check the Purezone App > Supply Levels for status.	The Purezone is ready for use.
Orange flash.	Intermittent Orange LED flash	Battery charge could be low. Check the Purezone App > Supply Levels for details.

# FIND HELP

## SAFETY

## PREPARATION

## WHAT'S IN THE BOX

## INSTALL DOCK

Tools Needed

## ADD A SPA

## SET UP PUREZONE WITH DOCK

## SET UP PUREZONE WITH HOVER

## REPLACE THE CASSETTE

## RECHARGE THE BATTERY

## YOUR PUREZONE SYSTEM

LED Status

FCC Information

Specifications

Troubleshooting

Ordering

Warranty

Software Agreement

## FCC INFORMATION

This device complies with part 15 of the FCC Rules. Operation is subject to the following two conditions: (1) This device may not cause harmful interference, and (2) this device must accept any interference received, including interference that may cause undesired operation.

## SPECIFICATIONS

18.5 Wh rechargeable Li-ion Battery Pack  
2.4 | 5.0 GHz Router  
Compliance: WPC V1.2  
For Spas or Swim Spas up to 2400 gallons (9,084 L)

## TROUBLESHOOTING

What You See	What It Means
App connection	Check that power is on, and no outages have occurred. Check that Bluetooth and Wi-Fi are on and available. Check proximity of your router. Promptly put Purezone in the spa after assembly, and in phone > Bluetooth connect the device.
Cassette testing	Try to uninstall and reinstall the App. Keep cassettes in their foil bags until you use them.
Testing	Cassettes in use for testing expire after 60 days from installation. Of your 48 tests, the first is used as initialization during setup. The testing measures Potential of hydrogen (pH), free chlorine (FC) or total bromine (TB), and total alkalinity (TA). Change test frequency between daily and every other day in-App. Set routine every other day, daily in-App Settings (⚙) > Measurement Time. On-Demand uses additional tests within a 48-test count cassette. Routine test results availability default to 9:00 AM local time.
Treatment variations	Treatment advice can change depending on extreme climate or number of spa users. Check your answers from "Preparation" on page 3 when adding your spa, and if needed, delete and add the spa again with correct information to customize your water care advice.

## ORDERING

Need more supplies? Visit: <https://purezonebybalboa.com>  
For more help: <https://purezonesupport.balboawater.com>

## WARRANTY

The Balboa Water Group, Inc. warrants to the first consumer purchaser of this product that it is free from defect in materials and /or workmanship for a period of 1 year from the date of purchase.

## SOFTWARE AGREEMENT

Use of this product and the software embedded within the product is subject to the copyright notices, terms, and conditions available at: <https://www.balboawater.com/support/purezone-terms-and-conditions/>

# FIND HELP

## SAFETY

## PREPARATION

## WHAT'S IN THE BOX

## INSTALL DOCK

Tools Needed

## ADD A SPA

## SET UP PUREZONE WITH DOCK

## SET UP PUREZONE WITH HOVER

## REPLACE THE CASSETTE

## RECHARGE THE BATTERY

## YOUR PUREZONE SYSTEM

LED Status

FCC Information

Specifications

Troubleshooting

Ordering

Warranty

Software Agreement



PLEASE  
VISIT US

Balboa  
2020 Piper Ranch Road  
San Diego, CA 92154  
Phone: 714.384.0384  
www.balboawater.com



[www.spafix.dk](http://www.spafix.dk) - [info@spafix.dk](mailto:info@spafix.dk)